

# Assembly Instructions

## FOR CLASSIC CRIB



Model shown is example only.  
Styles may vary



**STOP**

**IF YOU EXPERIENCE ANY  
ISSUES WITH THIS PRODUCT**

**BEFORE YOU  
RETURN THIS TO  
THE RETAILER**

**PLEASE FOLLOW  
PROCEDURES ON THE  
REVERSE SIDE OF THIS FORM.**

# Furniture Care Instructions

## Room Climate Control

Wood, when first cut contains more than 50 percent water. When it is prepared for furniture construction it is placed in a Kiln and the moisture content is brought down to 8 to 10 percent. Wood is porous and responds to its environment. If the room has high humidity it will absorb it and expand and if the humidity is low it will lose moisture and shrink.

It is important that the humidity levels in the room be controlled from extremes of too much humidity or too little. Furniture should not be placed close to air-conditioning outlets, fire places, radiators, space heaters, humidifiers or dehumidifiers. Exposure to extreme variations of temperature and humidity can damage any fine wood product.

## The Ideal Environment for Fine Furniture

Fine wood furniture will have fewer problems when its environment is controlled at a temperature between 65 and 75 degrees and a relative humidity between 35 and 40 percent. Wood placed in an environment outside of those limits can and will shrink or expand and may develop some small cracks which are not material or structural defects.

## Sticking Doors and Drawers

With the minor changes in temperature and humidity doors and drawers may swell and be difficult to open or close. Tolerances have been built into the units but extreme conditions may still cause sticking. This will adjust back to normal over time but until it does consider using a dehumidifier or rub candle wax or paraffin on the sides that stick.

## Avoid Direct Sunlight

Keep the furniture out of direct sunlight. Ultraviolet rays will fade colors and in some cases darken them. It can also cause crazing or hair line cracks in the finish. White finishes will yellow naturally over time and exposure to direct sunlight will hasten this natural process along with some woods darkening naturally over time; this is not considered to be a quality defect.

## Proper Storage

If you need to put your furniture in storage for any period of time do not store them in a damp basement or hot dry attic. Allow air movement around the furniture and do not stack anything on it.

## In General

- Protect furniture surface from hot or extremely cold items.
- Use coasters under hot or cold beverages
- Do not use synthetic fabric under accessories or lamps
- Protect tops from pens, markers and crayons
- Oils from potpourri and other scented items can damage the furniture finish.
- Do not drag items across the surface of the furniture.
- Allow the surface to breath by rotating your accessories and lamps.
- Do not over polish the furniture, do it only two or three times a year. Over polishing can distort the natural finish of the product.
- Do not wax the furniture as wax build up can destroy the natural finish of the product.
- When moving furniture always lift the unit. Do not push or drag it to avoid damage to legs
- Keep the furniture level so doors and drawers open and close freely.
- Clean with a damp, not wet, cloth. Use only a mild soap. Do not use abrasive cleaners.

## **Product Assistance Procedures**

**You have purchased a quality piece of furniture. Our international team has spent many hours designing and engineering this piece and packaging to ensure you will be satisfied with your purchase. But if for any reason you need help with your purchase please contact us at any time.**

### **Procedures to follow should you have any questions:**

**For best and most timely service please contact us by e-mail at [info@lajobi.com](mailto:info@lajobi.com)**

**Please provide the following information in your e-mail.**

- 1. Your Name** \_\_\_\_\_
- 2. Address** \_\_\_\_\_  
\_\_\_\_\_
- 3. Phone number** \_\_\_\_\_
- 4. Place and date of purchase** \_\_\_\_\_  
\_\_\_\_\_
- 5. Item number and description of your product.** \_\_\_\_\_  
\_\_\_\_\_

**The item number can be found on the back of the case or on the foot/headboard of the crib. Please include all numbers found on that label including the PO# and production date.**

- 6. Short description of the issues and attach a photo if possible.**  
\_\_\_\_\_  
\_\_\_\_\_  
\_\_\_\_\_

**Someone will contact you via e-mail or phone to help you with your issues.**

**If you do not have internet access, please fax the above information to 609-409-5809**

**If you do not have internet or fax access, please call us at 888-266-2848 and be sure to have all the above information ready to give to your Client Service Specialist.**

# **WARNING!**

- FAILURE TO FOLLOW THESE WARNINGS AND ASSEMBLY INSTRUCTIONS COULD RESULT IN SERIOUS INJURY OR DEATH.
- TO REDUCE THE RISK OF SIDS, PEDIATRICIANS RECOMMEND HEALTHY INFANTS BE PLACED ON THEIR BACKS TO SLEEP, UNLESS OTHERWISE ADVISED BY YOUR PHYSICIAN.
- CHECK THIS PRODUCT FOR DAMAGED HARDWARE, LOOSE JOINTS, MISSING PARTS OR SHARP EDGES BEFORE AND AFTER ASSEMBLY AND FREQUENTLY DURING USE.
- **DO NOT USE THIS CRIB IF ANY PARTS ARE MISSING, DAMAGED OR BROKEN. CONTACT LAJOBI INC. 257 PROSPECT PLAINS RD. CRANBURY NJ 08512 FOR REPLACEMENT PARTS AND INSTRUCTIONAL LITERATURE IF NEEDED. DO NOT SUBSTITUTE PARTS.**
- **DO NOT USE A WATER MATTRESS WITH THIS CRIB.**
- READ ALL INSTRUCTIONS BEFORE ASSEMBLING CRIB. **KEEP INSTRUCTIONS FOR FUTURE USE.**
- IF REFINISHING, USE A NON-TOXIC FINISH SPECIFIED FOR CHILDREN'S PRODUCTS.

## **STRANGULATION HAZARD:**

- STRINGS CAUSE STRANGULATION! DO NOT PLACE ITEMS WITH A STRING AROUND A CHILD'S NECK, SUCH AS HOOD STRINGS OR PACIFIER CORDS. **DO NOT** SUSPEND STRINGS OVER A CRIB OR ATTACH STRINGS TO TOYS.
- TO HELP PREVENT STRANGULATION TIGHTEN ALL FASTENERS. A CHILD CAN TRAP PARTS OF BODY OR CLOTHING ON LOOSE FASTENERS.
- **DO NOT** PLACE CRIB NEAR WINDOW WHERE CORDS FROM BLINDS OR DRAPES MAY STRANGLE A CHILD.
- INFANTS CAN SUFFOCATE ON SOFT BEDDING.
- NEVER ADD A PILLOW, COMFORTER OR PADDING.
- NEVER USE PLASTIC SHIPPING BAGS OR ANY PLASTIC FILM AS MATTRESS COVERS, BECAUSE THEY CAN CAUSE SUFFOCATION.
- INFANTS CAN SUFFOCATE IN GAPS BETWEEN CRIB SIDES AND A MATTRESS THAT IS TOO SMALL. **ANY MATTRESS USED IN THIS CRIB MUST BE AT LEAST 27-1/4 INCHES (69 CENTIMETERS) BY 51-5/8 INCHES (131 CENTIMETERS), WITH A THICKNESS NOT EXCEEDING 6 INCHES (15 CENTIMETERS).** THE DIMENSIONS OF THE MATTRESS SHALL BE TAKEN FROM SEAM TO SEAM OR EDGE TO EDGE WHERE APPROPRIATE.

## **FALL HAZARD:**

- WHEN CHILD IS ABLE TO PULL TO STANDING POSITION, SET MATTRESS TO LOWEST POSITION AND REMOVE BUMPER PADS, LARGE TOYS AND OTHER OBJECTS THAT COULD SERVE AS STEPS FOR CLIMBING OUT.
- AFTER RAISING SIDE, MAKE SURE LATCHES ARE SECURE (*DISREGARD FOR NON-DROP SIDE CRIB*).
- **DO NOT** LEAVE CHILD IN CRIB WITH SIDES LOWERED. BE SURE SIDE IS IN RAISED AND LOCKED POSITION WHENEVER CHILD IS IN CRIB (*DISREGARD FOR NON-DROP SIDE CRIB*).
- WHEN THE CHILD IS ABLE TO CLIMB OUT OR REACHES THE HEIGHT OF 35 INCHES (90 CENTIMETERS), THE CRIB SHALL NO LONGER BE USED.
- WHEN STORING CRIB USE CAUTION AS EXTREME CHANGES IN TEMPERATURE OR HUMIDITY CAN COMPROMISE THE CRIB MAKING IT EXTREMELY DANGEROUS TO YOUR CHILD.
- USE CAUTION WHEN A VAPORIZER OR HUMIDIFIER IS IN USE. ALWAYS AIM VAPOR AWAY FROM THE CRIB AS WELL AS ANY OTHER WOODEN FURNITURE. PROLONGED PERIODS OF HUMIDITY IN STORAGE AS WELL AS THE HOME CAN COMPROMISE THE CRIB.
- AVOID USING VAPORIZERS AND HUMIDIFIERS FOR PROLONGED PERIODS OF TIME.
- FOLLOW WARNINGS ON ALL PRODUCTS IN CRIB.

Thank you for choosing a Bonavita Product. To ensure the best performance from your crib, please read the following instructions carefully. Carefully remove and lay out all parts. Familiarize yourself with all exhibits and diagrams to facilitate the assembly of your crib.

Please call LaJobi with any comment or questions. Do not return to retailer.

**TOOLS REQUIRED:** Phillipshead and slotted screwdriver, hammer, Allen wrench (supplied), small flat piece of wood.

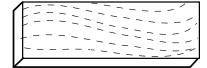
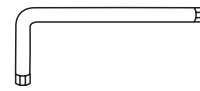
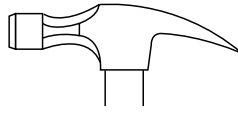
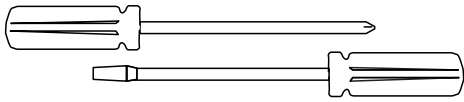

**IMPORTANT: DO NOT USE POWER DRILLS OR DRIVERS**

**PARTS ENCLOSED IN CARTON**

Model shown is example only. Styles may vary

**A** (2) Stabilizer Bars

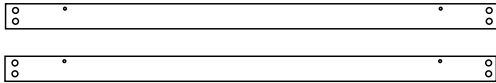

**B** (1) Mattress Spring with Support Brackets

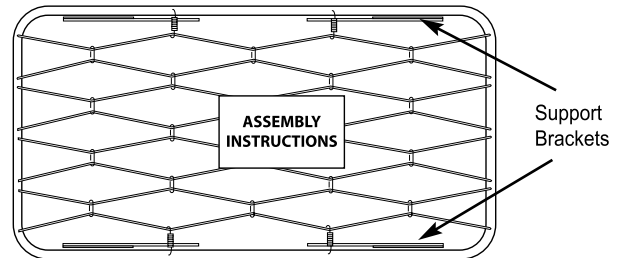

**C** (2) Stationary Rails

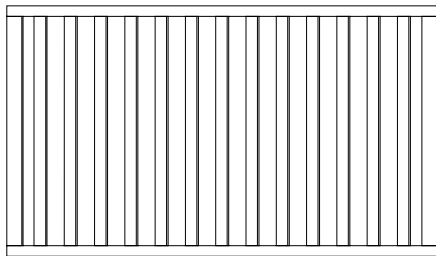

**D** (1) Left Headboard & (1) Right Footboard

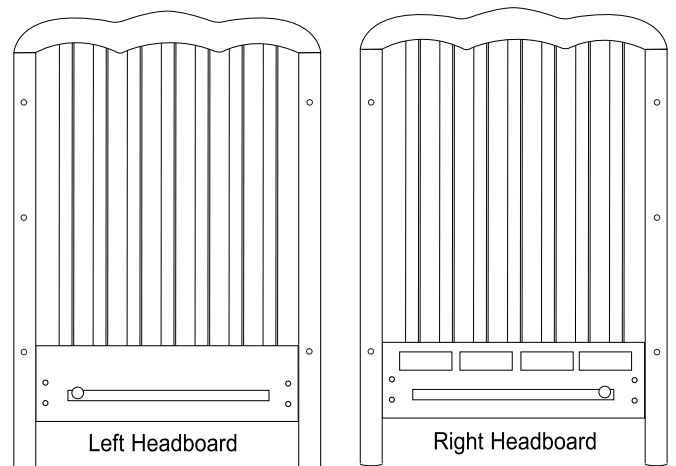

**E** (1) Guard rail (Not included, Sold separately)

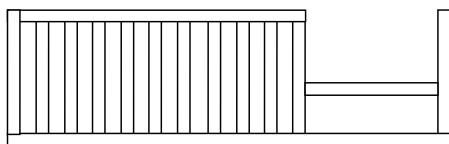

**F** Drawer front & back panels

Drawer sides & center panel

(1) Drawer bottom

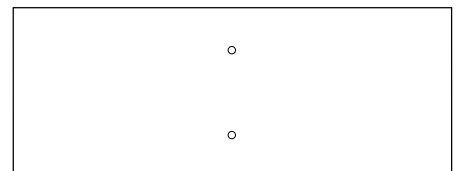
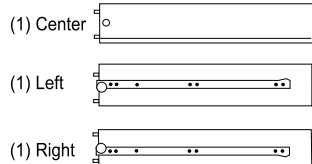
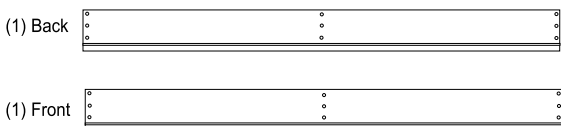

**PARTS ENCLOSED IN HARDWARE BAG**

**G** (8) Allen head Bolt 2-7/8"

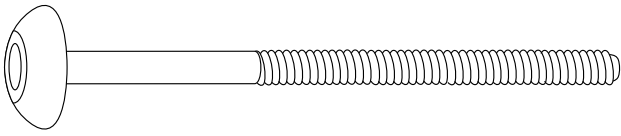

**H** (16) Washers



**I** (8) Barrel Nut

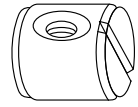

**J** (8) Allen head Bolt 2"

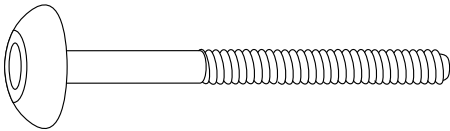

**K** (8) Phillips head Screw 1-1/4"

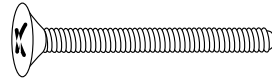

**L** (8) Wing Nut

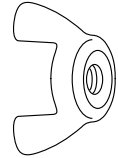

**M** (1) Allen Wrench

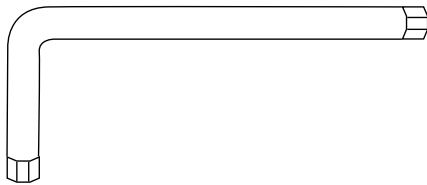

**O** (4) Caster (2-Safety Locking Side)

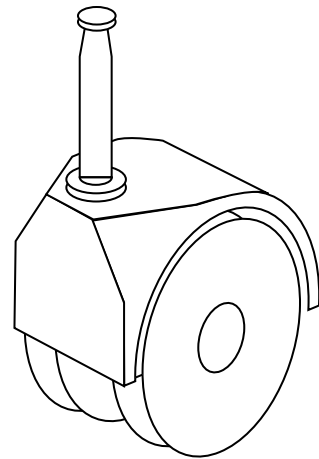

**N** (16) Lock Washers



**PARTS ENCLOSED IN HARDWARE BAG**

**P** (3) Mini Blocks

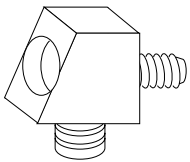

**Q** (3) Phillips Wood Screws

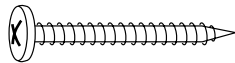

**R** (2) Pan head Phillips Screw

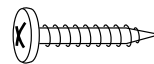

**S** (4) Horseshoe Washers

See step 7C  
Use washers only  
if drawer fits too  
loose in its tracks.

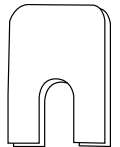

**CARE & MAINTENANCE**

WHEN CLEANING YOUR CRIB, USE A NON-TOXIC, NON ABRASIVE CLEANER. MIX A SOLUTION OF WATER WITH A SMALL AMOUNT OF A MILD DISHWASHING LIQUID. APPLY TO CRIB SURFACE WITH A SOFT DAMP CLOTH LIGHTLY DAMPENED IN SOLUTION. AFTER CLEANING, DRY COMPLETELY WITH A SOFT DRY CLOTH.



Model shown is example only. Styles may vary

## STEP 1 Assembly of Stabilizer Bars

### THIS STEP REQUIRES:

2 STABILIZER BARS (A)  
LEFT HEADBOARD (D)  
RIGHT FOOTBOARD (D)

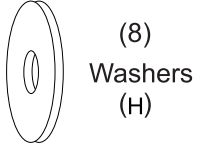

(8) Barrel Nut (I)



(8) Allen head Bolt 2-7/8" (G)

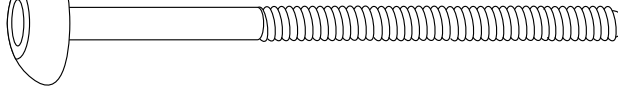

(1) Allen Wrench (M)

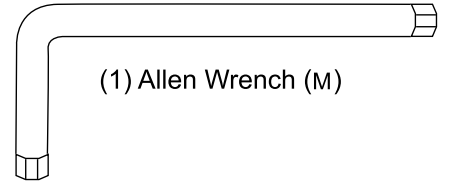

(8) Lock Washers (N)



**A.** ATTACH ONE STABILIZER BAR TO BOTH THE LEFT AND RIGHT CRIB ENDS AS SHOWN IN FIGURE 1.

**IMPORTANT:** THE BRACKET SUPPORT HOLES SHOULD BE AT THE TOP EDGE OF THE STABILIZER BARS.

**B.** START BY INSERTING THE BARREL NUT INTO THE PREDRILLED HOLES IN THE STABILIZER BAR. REFER TO FIGURE 1A TO MAKE SURE THE THREADED HOLE IN THE CENTER OF THE BARREL NUT IS PROPERLY ALIGNED TO CAPTURE THE ALLEN HEAD BOLT.

**NOTE:** MAKE SURE THAT THE BARREL NUT IS INSERTED WITH THE SLOTTED END FACING OUT.

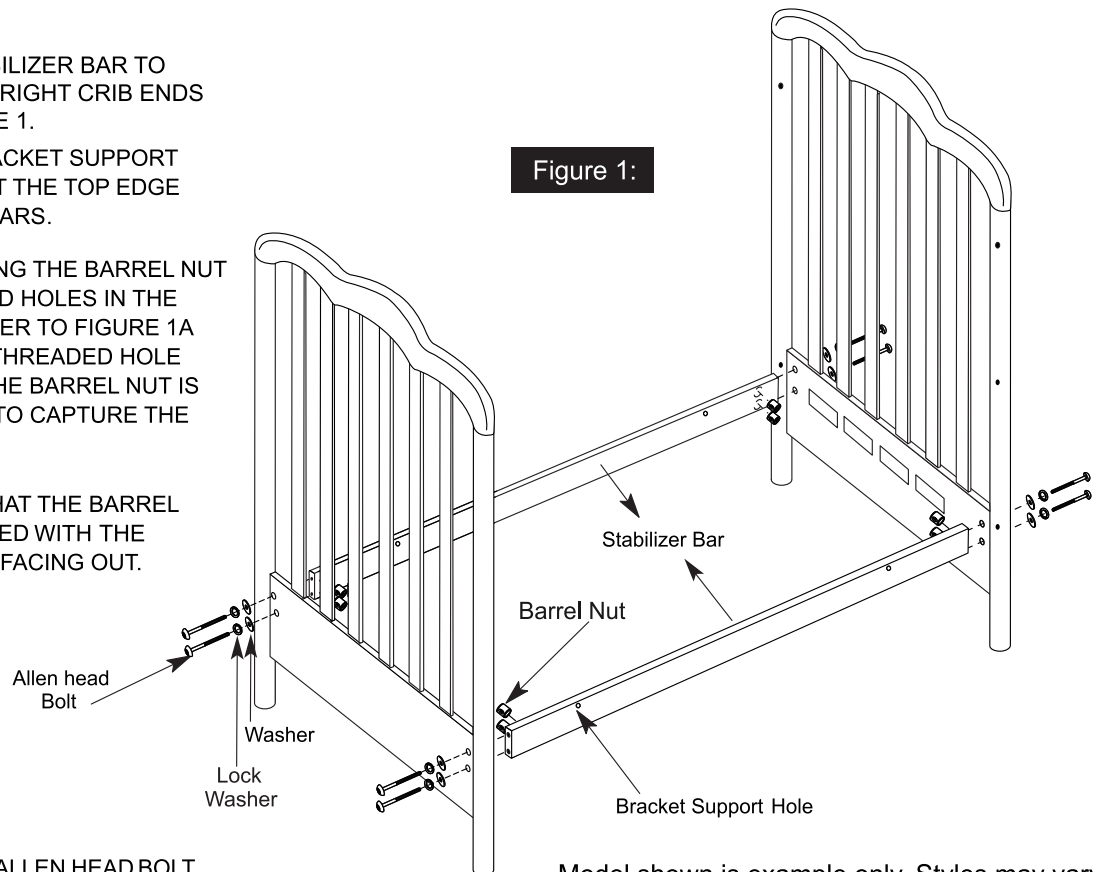

**C.** INSERT THE 2-7/8" ALLEN HEAD BOLT FIRST THROUGH THE LOCK WASHER, THEN THE WASHER, THEN THROUGH THE PRE-DRILLED HOLE IN THE HEADBOARD, AND FINALLY INTO THE HOLE IN THE END OF THE STABILIZER BAR TO JOIN WITH THE BARREL NUT. TIGHTEN WITH THE ALLEN WRENCH. (FIGURE 1A)

REPEAT ON 3 REMAINING CORNERS.

Model shown is example only. Styles may vary

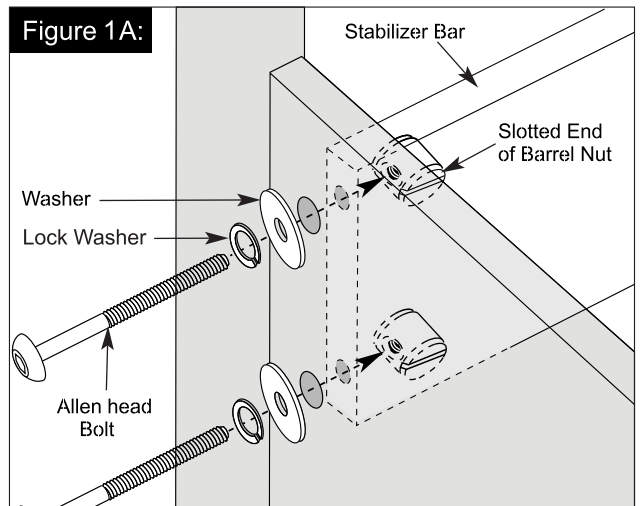

## STEP 2 Attaching the Spring

THIS STEP REQUIRES:

1 MATTRESS SPRING (B)

(8) Phillips head Screws 1-1/4" (K)

(8) Wing Nuts (L)

**A** OPEN EACH SUPPORT BRACKET ON THE MATTRESS SPRING TO FORM A "Y". (FIGURE 2).

Figure 2:

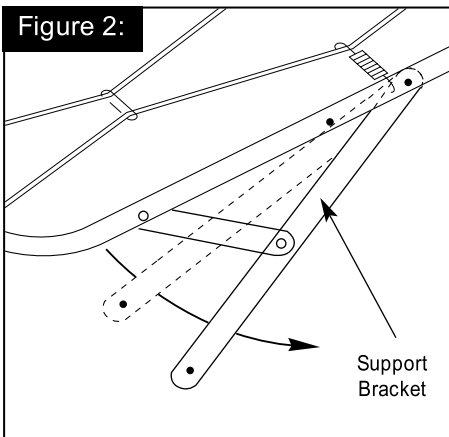

Model shown is example only  
Styles may vary

Figure 2A:

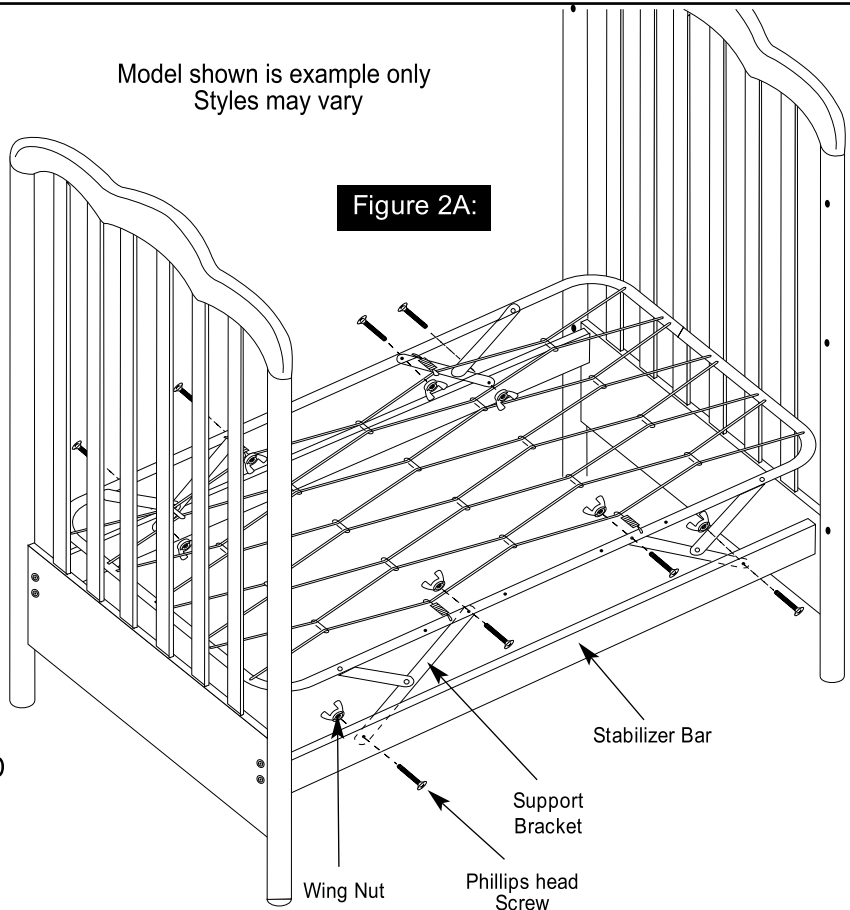

**B** INSERT THE PHILLIPS HEAD SCREW THROUGH THE STABILIZER BAR, THEN THROUGH THE SUPPORT BRACKET AND TIGHTEN SECURELY WITH A WING NUT. (FIGURE 2A & 2B).

**C** THE 3 HOLES ALONG THE SIDES OF THE MATTRESS SPRING ARE USED FOR HEIGHT ADJUSTMENT. (FIGURE 2B) SELECT A HOLE FOR THE DESIRED HEIGHT AND THEN INSERT A PHILLIPS HEAD SCREW THROUGH THE MATTRESS SPRING, THEN THROUGH THE SUPPORT BRACKET AND TIGHTEN SECURELY WITH A WING NUT. REPEAT FOR THE REMAINING BRACKETS.

**NOTE:** WE RECOMMEND SETTING THE SPRING IN THE HIGHEST POSITION FOR NEWBORN BABIES AND LOWERING THE SPRING AS THE CHILD GROWS AND BECOMES MORE MOBILE.

Figure 2B:

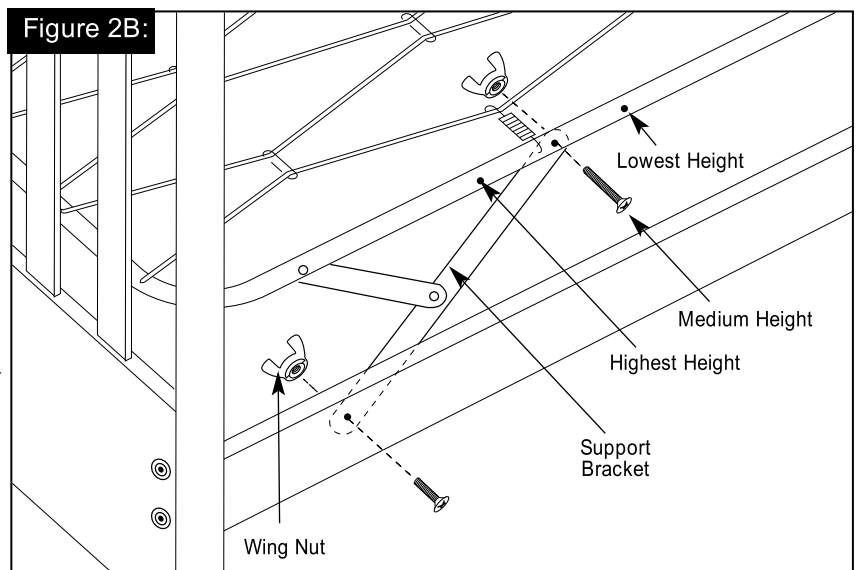

## STEP 3 Stationary Rail Installation

THIS STEP REQUIRES:

2 STATIONARY RAILS (C)

(8) Lock Washers (N)

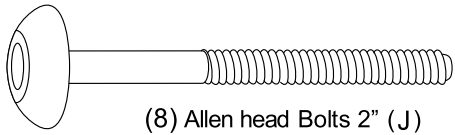

(8) Washers (H)

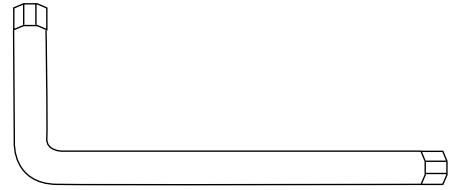

Allen wrench (M)

Figure 3:

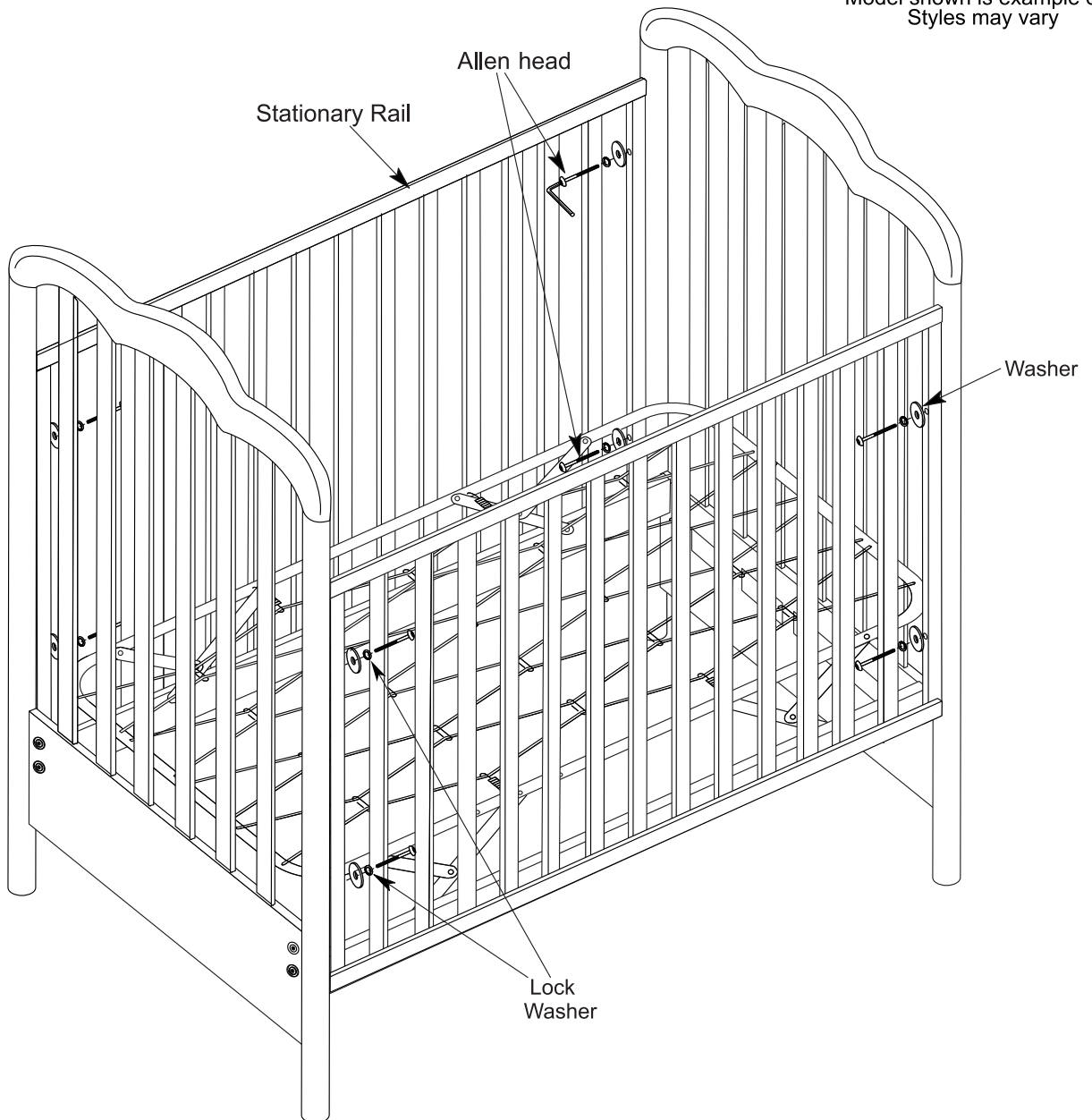

Attach the two stationary rails to the left and right crib ends by inserting the 2" Allen head bolts through the lock washers and washers, then into the pre-drilled holes in the stationary sides and into the crib ends. Tighten with Allen wrench. Repeat on the other stationary side.

## STEP 4 Wheel Installation (optional)

THIS STEP REQUIRES:

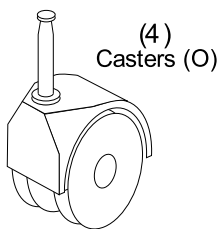

CAREFULLY TAP THE CASTER SPINDLE INTO THE HEADBOARD LEG USING A PIECE OF WOOD TO CUSHION THE BLOWS. REPEAT PROCESS ON REMAINING 3 LEGS.

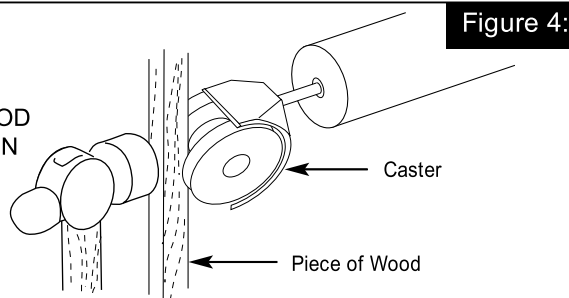

## STEP 5 Drawer Assembly

THIS STEP REQUIRES:

DRAWER FRONT AND BACK  
DRAWER RIGHT, CENTER & LEFT PANELS  
DRAWER BOTTOM

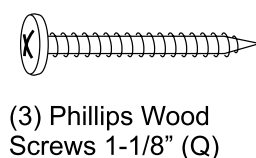
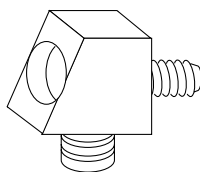

**A** INSERT MINI BLOCK INTO CENTER OF EACH DRAWER END AND CENTER SUPPORT (FIGURE 7).

**NOTE:** BE SURE TO POSITION THE DRAWER PANELS AS PICTURED IN FIGURE 5.

**B** INSERT THE RIGHT, LEFT AND CENTER PANELS INTO THE DRAWER BACK PANEL AND SECURE USING THE PHILLIPS WOOD SCREWS (FIGURE 5A).

**C** SLIDE THE DRAWER BOTTOM INTO THE RESPECTIVE GROOVE OF THE DRAWER BACK, THEN THE LEFT AND RIGHT DRAWERS PANELS (FIGURE 5A).

**D** INSERT THE DRAWER FRONT ONTO THE RESPECTIVE LEFT, CENTER AND RIGHT PANELS AND ALIGN THE MINI BLOCK HOLES IN THE DRAWER FRONT PANEL.

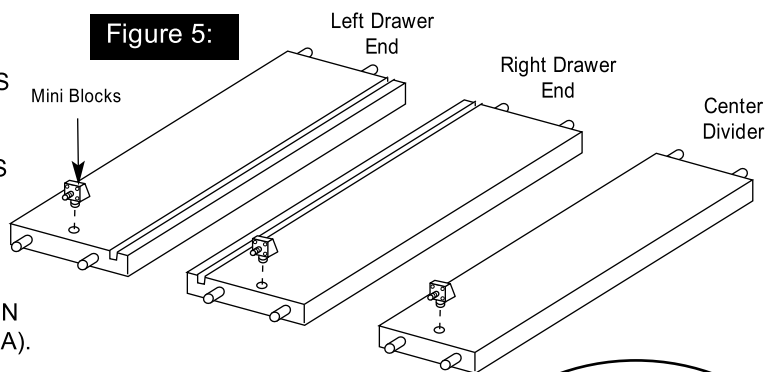

Figure 5A:

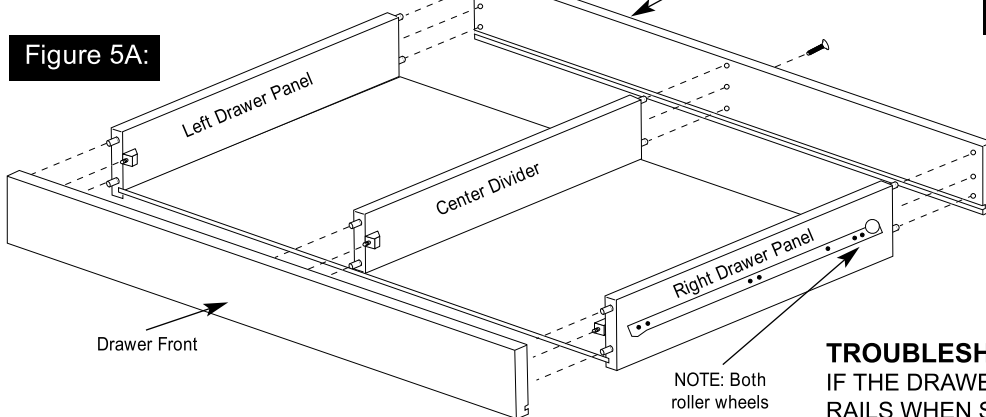
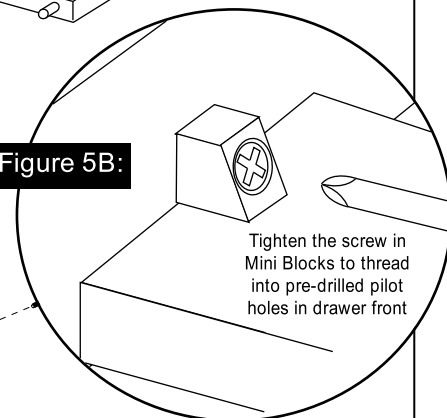

Figure 5B:



**E** SECURE THE DRAWER FRONT PANEL INTO PLACE USING THE MINI BLOCK SCREWS (FIGURE 5B).

**F** AFTER THE DRAWER IS FULLY ASSEMBLED, TURN THE DRAWER UPSIDE DOWN AND SCREW THE (2) PAN HEAD PHILLIPS SCREWS INTO THE BOTTOM CENTER SUPPORT.

### TROUBLESHOOTING

IF THE DRAWER FALLS OUT OF THE GUIDE RAILS WHEN SLIDING, LOOSEN SCREWS IN BOTH DRAWER GLIDES AND INSERT WASHERS AS SHOWN IN FIGURE 5C. RETIGHTEN THE SCREWS WITH THE WASHERS IN PLACE.

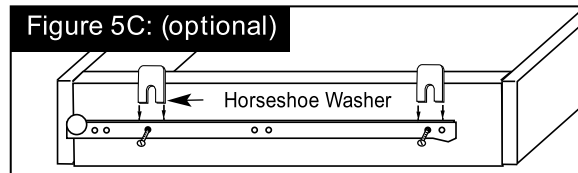

# **WARNING!**

## **For Toddler Bed Use**

- FAILURE TO FOLLOW THESE WARNINGS AND ASSEMBLY INSTRUCTIONS COULD RESULT IN SERIOUS INJURY OR DEATH FROM ENTRAPMENT OR STRANGULATION.
- DO NOT PLACE BED NEAR WINDOWS WHERE CORDS FROM BLINDS OR DRAPES MAY STRANGLE A CHILD.
- THE MATTRESS INTENDED FOR USE ON THE BED SHALL BE A FULL-SIZE CRIB MATTRESS HAVING THE DIMENSIONS OF 51-5/8 in. (1310 mm) IN LENGTH AND 27-1/4 in. (690 mm) IN WIDTH AND THICKNESS OF 4 in. (100mm) OR A GREATER THICKNESS AS SPECIFIED BY THE MANUFACTURER.
- THE MINIMUM AGE OF THE INTENDED USER SHALL NOT BE LESS THAN 15 MONTHS AND THE MAXIMUM WEIGHT SHALL NOT BE GREATER THAN 50 LBS. (22.7 KG).



257 Prospect Plains Road  
Cranbury, NJ 08512  
Phone: 888-266-2848, 609-409-2495  
Fax: 609-409-5809