

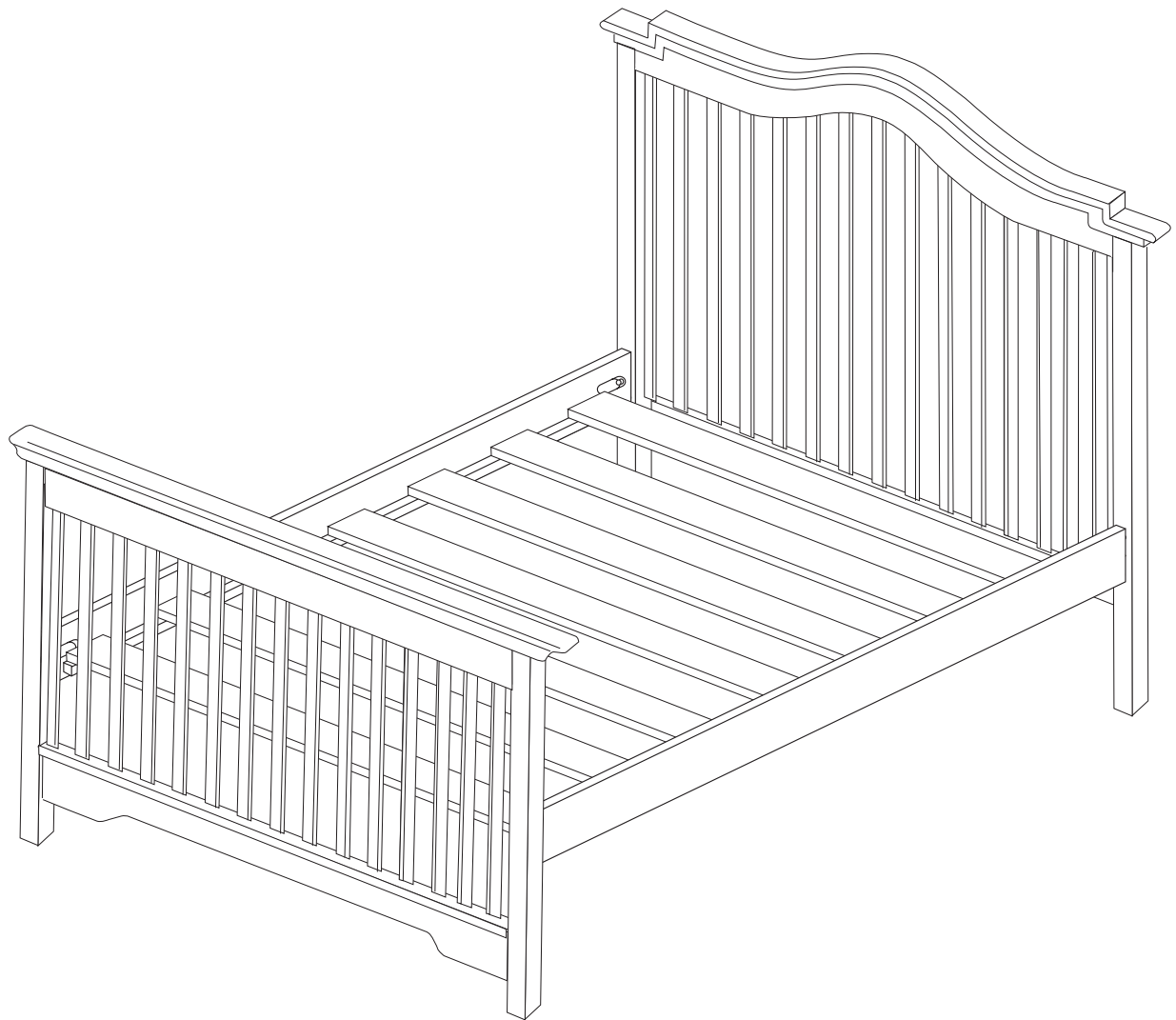

a division of LaJobi Industries



Assembly Instructions

For Bed Rail

Model shown is example only. Styles may vary

Furniture Care Instructions

Room Climate Control

Wood, when first cut contains more than 50 percent water. When it is prepared for furniture construction it is placed in a Kiln and the moisture content is brought down to 8 to 10 percent. Wood is porous and responds to its environment. If the room has high humidity it will absorb it and expand and if the humidity is low it will lose moisture and shrink.

It is important that the humidity levels in the room be controlled from extremes of too much humidity or too little. Furniture should not be placed close to air-conditioning outlets, fire places, radiators, space heaters, humidifiers or dehumidifiers. Exposure to extreme variations of temperature and humidity can damage any fine wood product.

The Ideal Environment for Fine Furniture

Fine wood furniture will have fewer problems when its environment is controlled at a temperature between 65 and 75 degrees and a relative humidity between 35 and 40 percent. Wood placed in an environment outside of those limits can and will shrink or expand and may develop some small cracks which are not material or structural defects.

Sticking Doors and Drawers

With the minor changes in temperature and humidity doors and drawers may swell and be difficult to open or close. Tolerances have been built into the units but extreme conditions may still cause sticking. This will adjust back to normal over time but until it does consider using a dehumidifier or rub candle wax or paraffin on the sides that stick.

Avoid Direct Sunlight

Keep the furniture out of direct sunlight. Ultraviolet rays will fade colors and in some cases darken them. It can also cause crazing or hair line cracks in the finish. White finishes will yellow naturally over time and exposure to direct sunlight will hasten this natural process along with some woods darkening naturally over time; this is not considered to be a quality defect.

Proper Storage

If you need to put your furniture in storage for any period of time do not store them in a damp basement or hot dry attic. Allow air movement around the furniture and do not stack anything on it.

In General

- Protect furniture surface from hot or extremely cold items.
- Use coasters under hot or cold beverages
- Do not use synthetic fabric under accessories or lamps
- Protect tops from pens, markers and crayons
- Oils from potpourri and other scented items can damage the furniture finish.
- Do not drag items across the surface of the furniture.
- Allow the surface to breath by rotating your accessories and lamps.
- Do not over polish the furniture, do it only two or three times a year. Over polishing can distort the natural finish of the product.
- Do not wax the furniture as wax build up can destroy the natural finish of the product.
- When moving furniture always lift the unit. Do not push or drag it to avoid damage to legs
- Keep the furniture level so doors and drawers open and close freely.
- Clean with a damp, not wet, cloth. Use only a mild soap. Do not use abrasive cleaners.

STOP

**IF YOU EXPERIENCE ANY
ISSUES WITH THIS PRODUCT**

**BEFORE YOU
RETURN THIS TO
THE RETAILER**

**PLEASE FOLLOW
PROCEDURES ON THE
REVERSE SIDE OF THIS FORM.**

Product Assistance Procedures

You have purchased a quality piece of furniture. Our international team has spent many hours designing and engineering this piece and packaging to ensure you will be satisfied with your purchase. But if for any reason you need help with your purchase please contact us at any time.

Procedures to follow should you have any questions:

For best and most timely service please contact us by e-mail at info@lajobi.com

Please provide the following information in your e-mail.

1. Your Name _____
2. Address _____

3. Phone number _____
4. Place and date of purchase _____

5. Item number and description of your product. _____

The item number can be found on the back of the case or on the foot/headboard of the crib. Please include all numbers found on that label including the PO# and production date.

6. Short description of the issues and attach a photo if possible.

Someone will contact you via e-mail or phone to help you with your issues.

If you do not have internet access, please fax the above information to 609-409-5809

If you do not have internet or fax access, please call us at 888-266-2848 and be sure to have all the above information ready to give to your Client Service Specialist.

Thank you for choosing a Bonavita Product. To ensure the best performance from your bed, please read the following instructions carefully.

Carefully remove and lay out all parts. Familiarize yourself with all exhibits and diagrams to facilitate the assembly of your bed.

Please call Lajobi with any comments or question, Do not return to retailer.

TOOLS REQUIRED: Phillipshead screwdriver

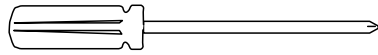

PARTS ENCLOSED IN CARTON

A (2) Bed Rails

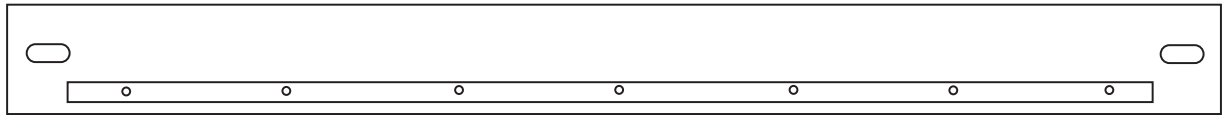

B (7) Bed Slats

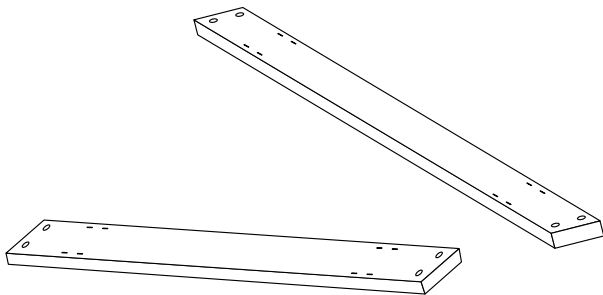

C (2) Headboard Post Attachments

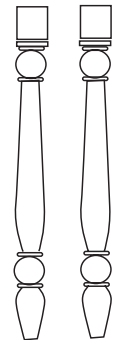

PARTS ENCLOSED IN HARDWARE BAG

D (28) Phillips head Screw 1"

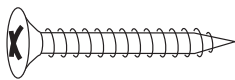

E (4) Allen head Bolt 2-3/8"

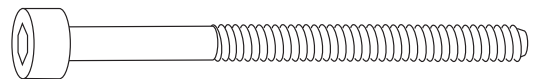

F (4) Metal Brackets

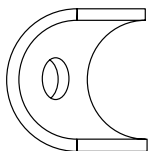

G (8) Iron Pins



H (1) Allen Wrench

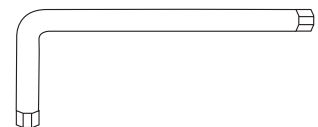

I (6) Allen head Bolt 2-1/2"

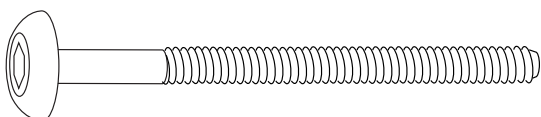

J (6) Washers



STEP 1 Headboard Post Attachment (Full Bed Conversion)

THIS STEP REQUIRES:

Headboard
Post Attachment (C)

Crib Hardware

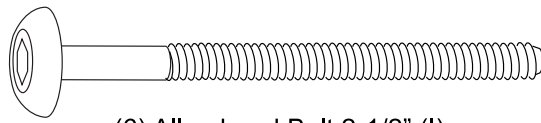

(6) Allen head Bolt 2-1/2" (I)



(6)
Washers
(J)

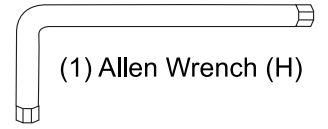

(1) Allen Wrench (H)

Figure 1:

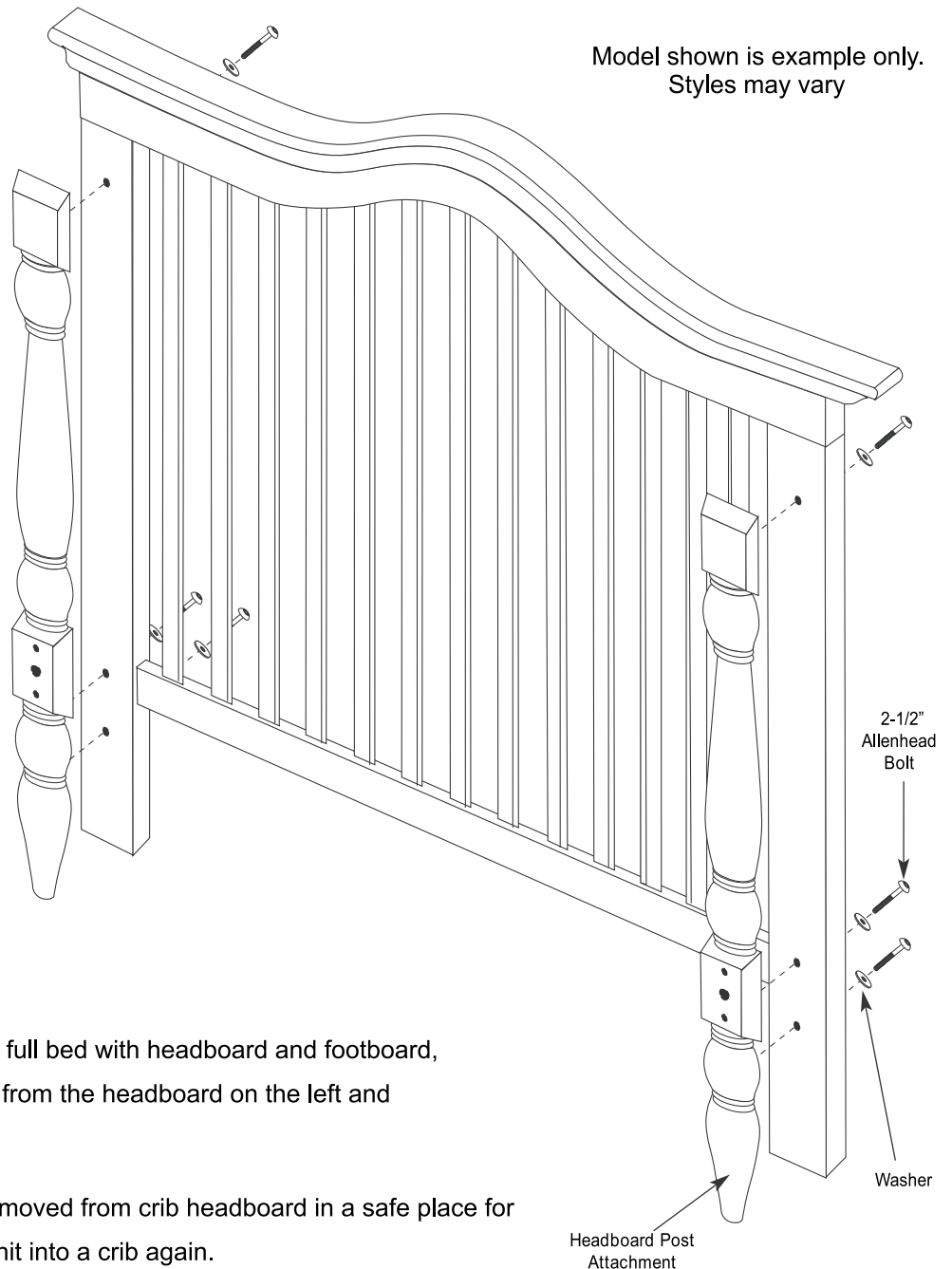

A. To convert lifestyle crib to a full bed with headboard and footboard, remove the 6 Allen head bolts from the headboard on the left and right side.

Note: Save the six (6) bolts removed from crib headboard in a safe place for reuse when assembling this unit into a crib again.

B. Using the (6) 2-1/2" Allen head bolts, included with hardware bag, attach the headboard post attachment to the headboard, Insert the (6) 2-1/2" Allen head bolt and post attachment (Fig.1) Secure with allen wrench.

STEP 2 Side Rail Installation

THIS STEP REQUIRES:

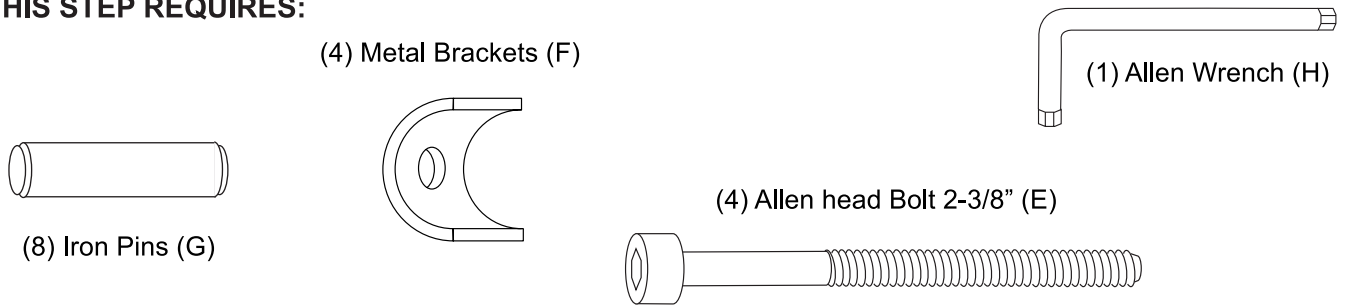
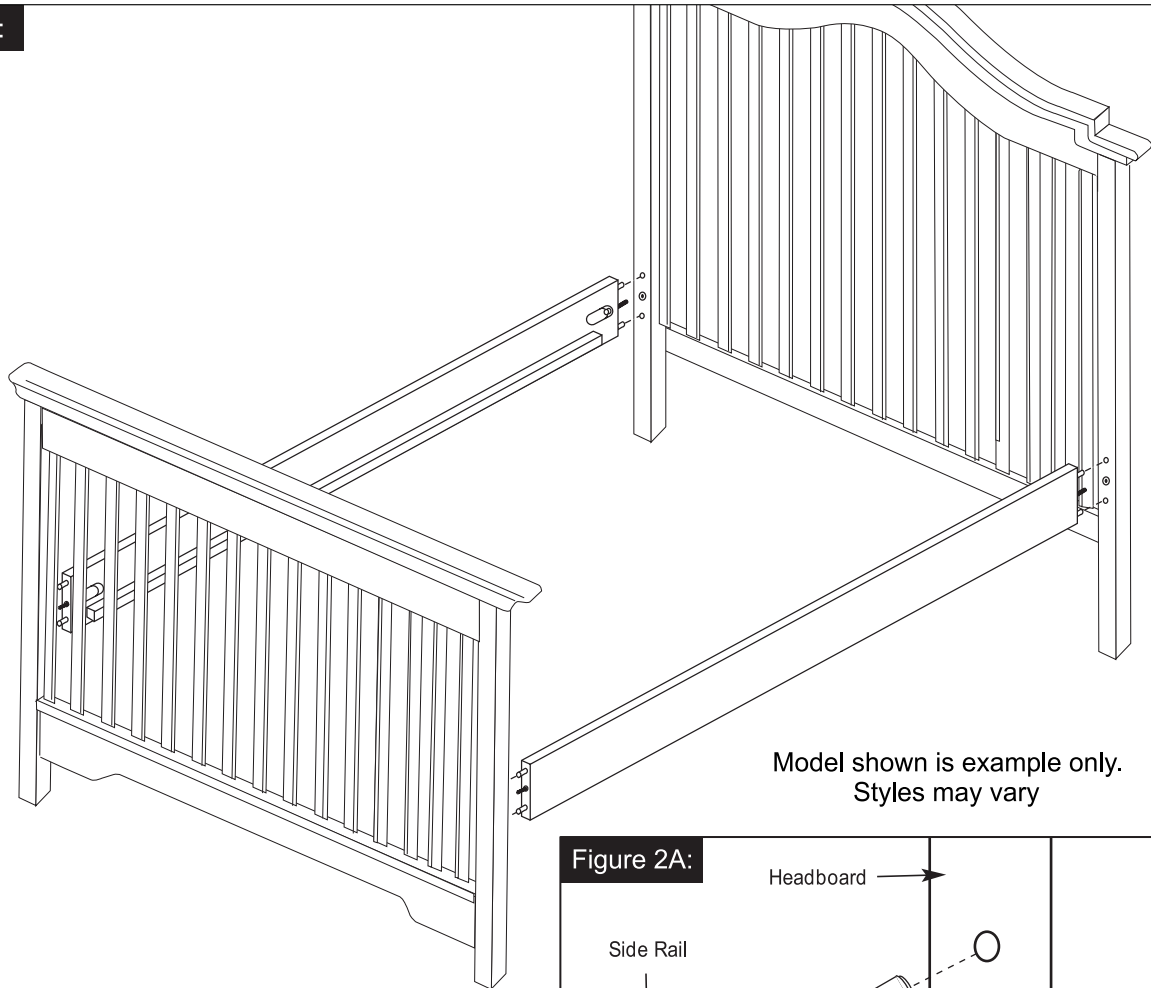

Figure 2:



Model shown is example only.
Styles may vary

A. Attach side rails to headboard and footboard by first inserting the iron pins into the side rail. If necessary, tap gently with hammer.

B. Insert the metal bracket into the opening in the side rail (position as shown in figure 2A).

C. Insert the Allen head bolt through the bracket and side rail and into the center hole in the headboard and/or footboard. Secure by tightening with the allen wrench. Repeat on all corners.

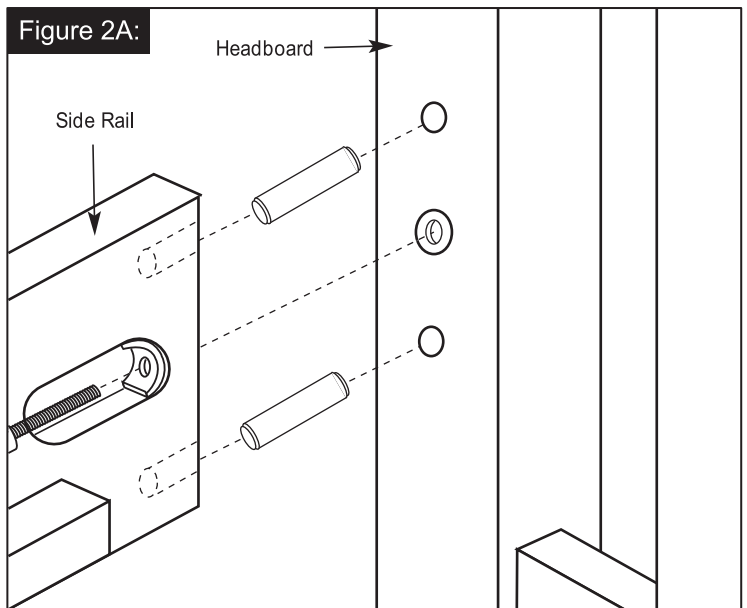

STEP 3 Bed Slats Installation

THIS STEP REQUIRES:

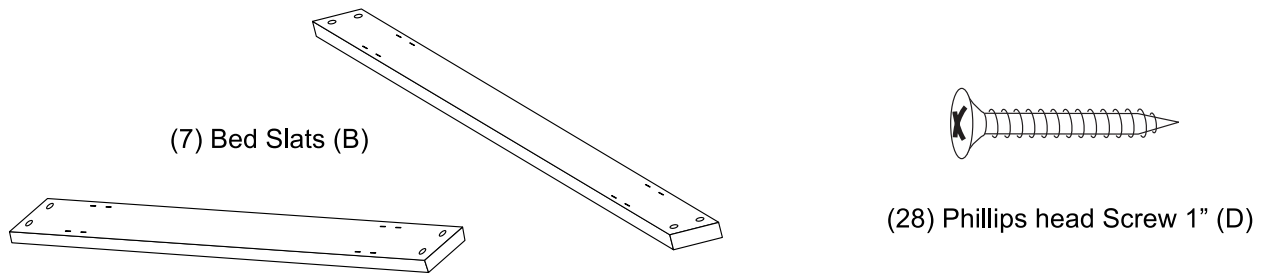
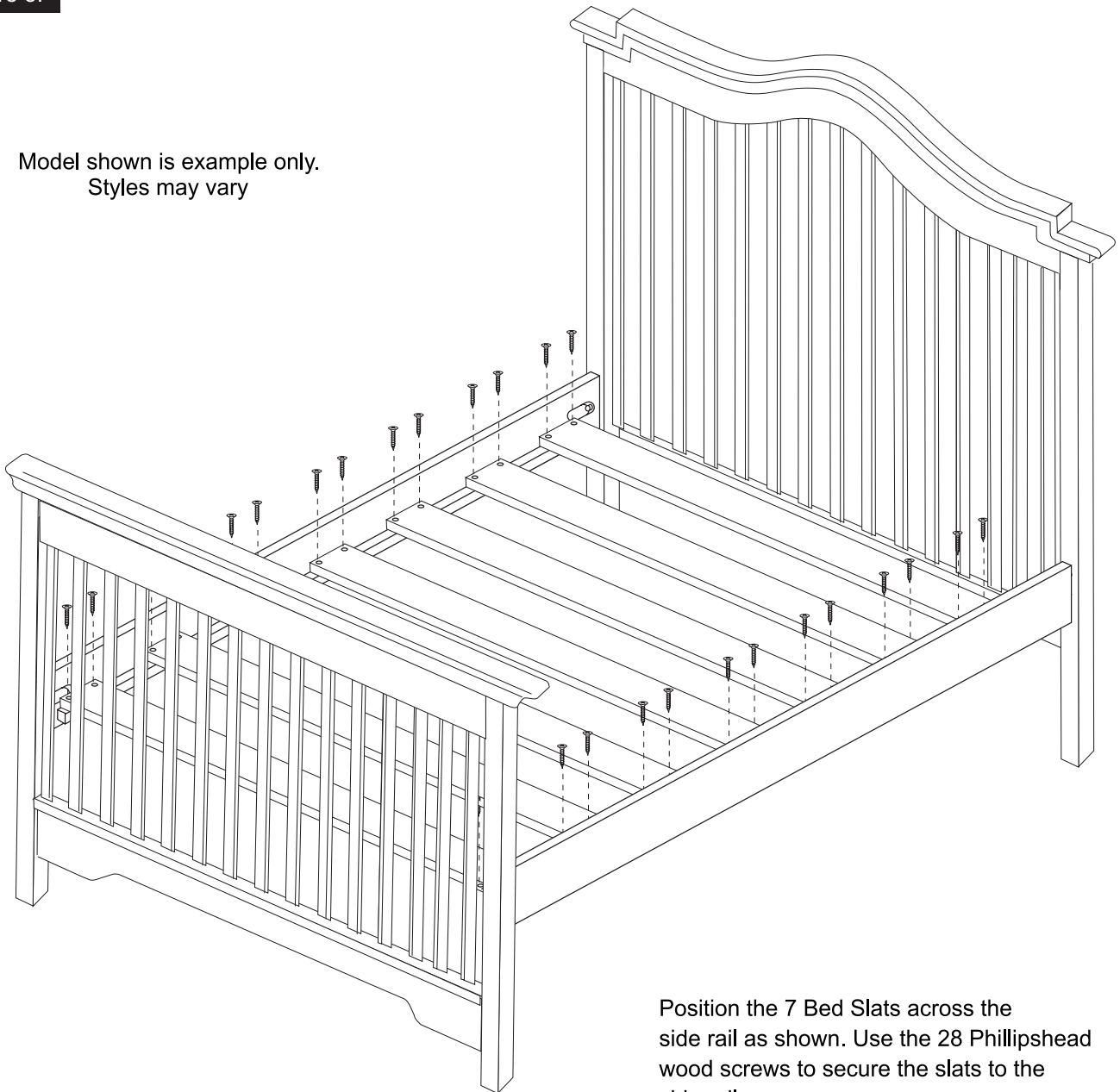

Figure 3:

Model shown is example only.
Styles may vary



Position the 7 Bed Slats across the side rail as shown. Use the 28 Phillipshead wood screws to secure the slats to the side rails.



a division of LaJobi Industries

257 Prospect Plains Road
Cranbury, NJ 08512
Phone: 888-266-2848, 609-409-2495
Fax: 609-409-5809